

A.V.R.

**R 438**

Installation and maintenance

# R 438

## A.V.R.

**This manual concerns the alternator A.V.R. which you have just purchased. We wish to draw your attention to the contents of this maintenance manual.**

### SAFETY MEASURES

Before using your machine for the first time, it is important to read the whole of this installation and maintenance manual.

All necessary operations and interventions on this machine must be performed by a qualified technician.

Our technical support service will be pleased to provide any additional information you may require.

The various operations described in this manual are accompanied by recommendations or symbols to alert the user to potential risks of accidents. It is vital that you understand and take notice of the following warning symbols.

#### WARNING

**Warning symbol for an operation capable of damaging or destroying the machine or surrounding equipment.**



**Warning symbol for general danger to personnel.**



**Warning symbol for electrical danger to personnel.**



**All servicing or repair operations performed on the AVR should be undertaken by personnel trained in the commissioning, servicing and main-tenance of electrical and mechanical components.**



**When the generator is driven at a frequency less than 28 Hz for more than 30 seconds with an analogic regulator, the AC power must be disconnected.**

#### WARNING

**This A.V.R. can be incorporated in a machine marked C.E. This manual is be given to the end user.**

© - We reserve the right to modify the characteristics of its products at any time in order to incorporate the latest technological developments. The information contained in this document may therefore be changed without notice.

This document may not be reproduced in any form without prior authorization. All brands and models have been registered and patents applied for.

# R 438 A.V.R.

## CONTENTS

<b>1 - SUPPLY</b> .....	<b>4</b>
1.1 - AREP excitation system .....	4
1.2 - PMG excitation system.....	5
1.3 - SHUNT or separate excitation system.....	5
<b>2 - R438 A.V.R.</b> .....	<b>6</b>
2.1 - Characteristics .....	6
2.2 - Frequency compared with voltage (without LAM).....	6
2.3 - LAM (Load Acceptance Module) characteristics.....	6
2.4 - Typical effects of the LAM with a diesel engine with or without a LAM (U/F only) .....	7
2.5 - R438 A.V.R. options .....	8
<b>3 - INSTALLATION - COMMISSIONING</b> .....	<b>9</b>
3.1 - Electrical checks on the AVR .....	9
3.2 - Settings .....	9
3.3 - Electrical faults .....	12
<b>4 - SPARE PARTS</b> .....	<b>13</b>
4.1 - Designation .....	13
4.2 - Technical support service .....	13

# R 438

## A.V.R.

### 1 - SUPPLY

#### 1.1 - AREP excitation system

For both AREP & PMG excitation systems, the alternator voltage regulator is the R438. With **AREP** excitation, the R438 electronic AVR is powered by two auxiliary windings which are independent of the voltage match circuit.

The first winding has a voltage in proportion

to that of the alternator (characteristic Shunt), the second has a voltage in proportion to the stator current (compound characteristic: Booster effect).

The power supply voltage is rectified and filtered before being used by the AVR monitoring transistor. This principle ensures that regulation is not affected by distortions generated by the load.

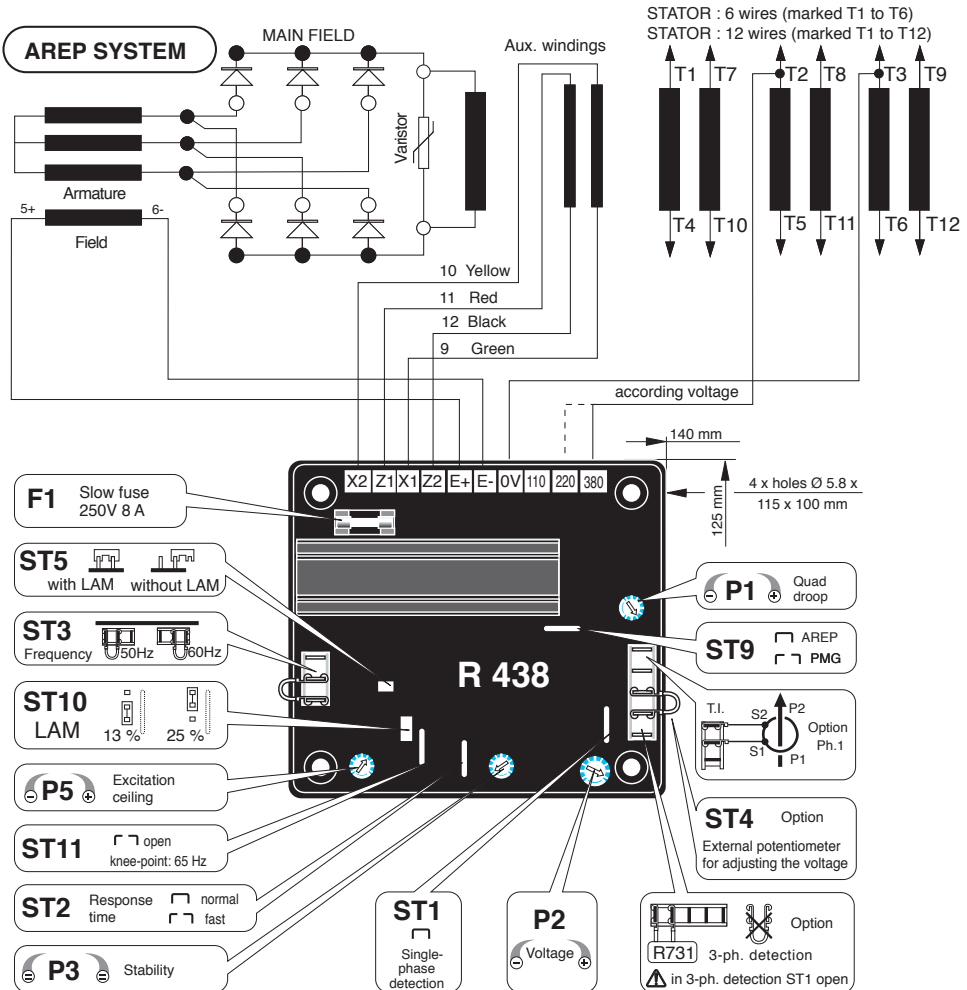

# R 438

## A.V.R.

### 1.2 - PMG excitation system

This excitation system consists of a «**PMG**» (permanent magnet generator). This is fitted at the rear of the machine and connected to the R438 AVR.

The PMG supplies the AVR with constant voltage which is independent of the main

alternator winding. As a result the machine has a short-circuit current capacity and good immunity to distortions generated by the load.

The AVR monitors and corrects the alternator output voltage by adjusting the excitation current.

- 50/60 Hz selection via the **ST3** jumper.

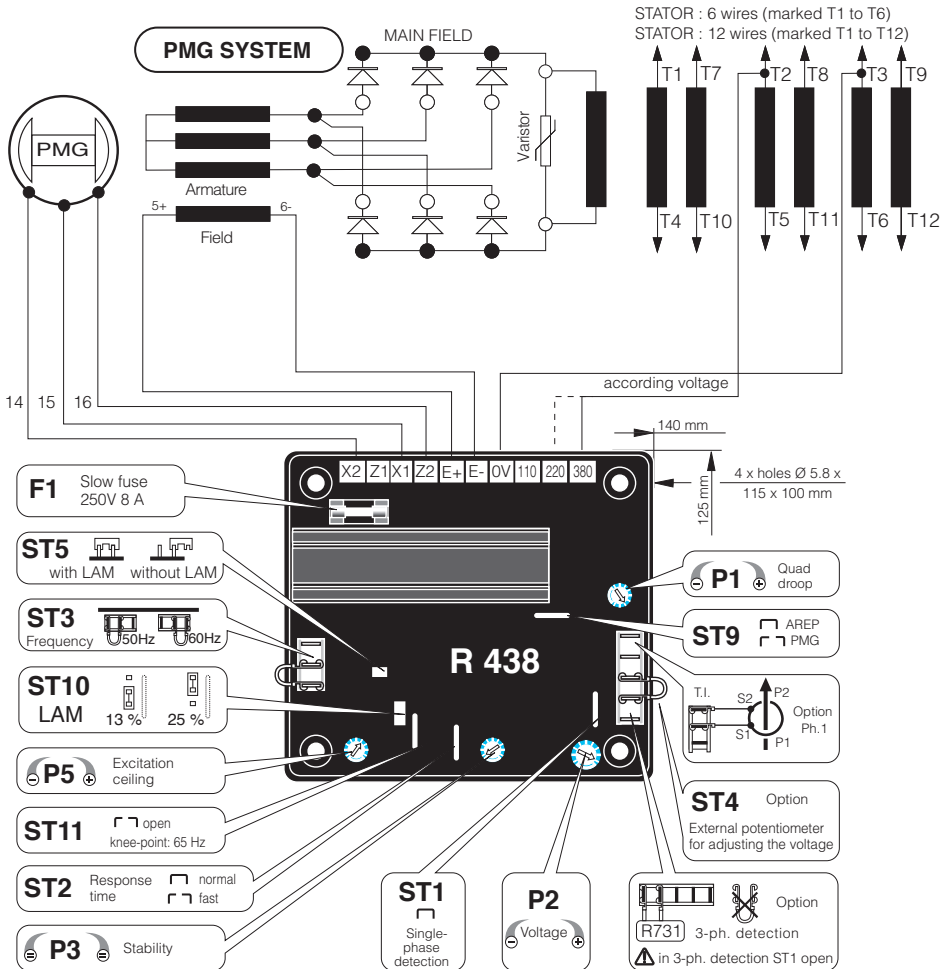

### 1.3 - SHUNT or separate excitation system

A.V.R. can be operated with SHUNT supply (with a transformer / secondary 50V or a 48V battery).

# R 438

## A.V.R.

## 2 - R438 A.V.R.

### 2.1 - Characteristics

- Storage : -55°C ; +85°C
- Operation : -40°C ; +70°C
- Standard power supply: AREP or PMG.
- Rated overload current: 8 A - 10 s
- Electronic protection (overload, short-circuit on opening of voltage sensing circuit): excitation overload current for 10 seconds then return to approximately 1A. The alternator must be stopped (or the power switched off) in order to reset the protection.
- Fuse : F1 on X1, X2. 8A ; slow - 250V
- Voltage sensing : 5 VA isolated via transformer ;
  - 0-110 V terminals = 95 to 140 V,
  - 0-220 V terminals = 170 to 260 V,
  - 0-380 V terminals = 340 to 520 V.
- Voltage regulation  $\pm 0.5\%$ .
- Normal or rapid response time via **ST2** jumper (see below).
- Voltage adjustment via potentiometer **P2**. other voltages via adapter transformer
- Current sensing (parallel operation): C.T. 2.5 VA cl1, secondary 1 A (optional).
- Quadrature droop adjustment via potentiometer **P1**.
- Max. excitation current adjustment via **P5** (see below).

#### 2.1.1 - Configuration jumpers function

Pot.	Delivery config.		Position	Function
	Open	Closed		
ST1	3-ph.	Mono		Open for module installation tri detection
ST2	Fast	Normal		Response time
ST3			50 ou 60 Hz	Frequency selection
ST4	External potentiometer	Without		Potentiometer
ST5	Without	With		LAM
ST9	Others (PMG...)	AREP		Supply
ST10			13% or 25%	LAM voltage drop amplitude
ST11	65 Hz	48 or 58 Hz		U/f function bend position

### 2.1.2 - Setting potentiometers function

Delivery position	Pot.	Function
0	P1	Quadrature droop ; // operation with C.T.
400V	P2	Voltage
Centre	P3	Stability
Maxi	P5	Excitation current ceiling

### 2.2 - Frequency compared with voltage (without LAM)

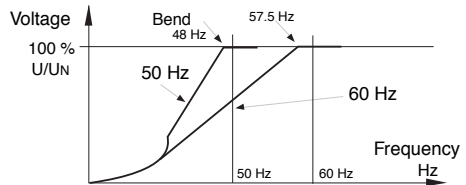

### 2.3 - LAM (Load Acceptance Module) characteristics

#### 2.3.1 - Voltage drop

The LAM system is integrated in the R 438 AVR as standard.

Role of the «LAM» (Load Adjustment Module) :

On application of a load, the rotation speed of the generator set decreases. When it passes below the preset frequency threshold, the LAM causes the voltage to drop by approximately 13% or 25% and consequently the amount of active load applied is reduced by approximately 25% to 50%, until the speed reaches its rated value again.

Hence the LAM can be used either to reduce the speed variation (frequency) and its duration for a given applied load, or to increase the applied load possible for one speed variation (turbo-charged engine).

To avoid voltage oscillations, the trip threshold for the LAM function should be set approximately 2 Hz below the lowest frequency in steady state.

# R 438

## A.V.R.

- LAM : action eliminated by cutting the ST5 jumper.

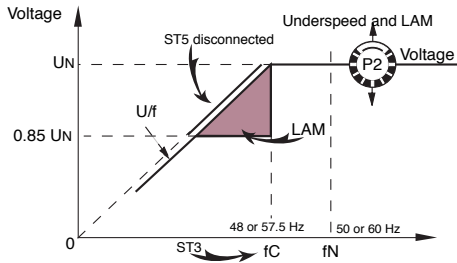

### 2.3.2 - Gradual voltage return function

During load impacts, the function helps the genset to return to its rated speed faster thanks to a gradual increase in voltage according to the principle:

- If the speed drops between 46 and 50 Hz, the rated voltage follows a fast gradient as it is restored.

- If the speed drops below 46 Hz, since the engine needs more help, the voltage follows a slow gradient as it returns to the reference value.

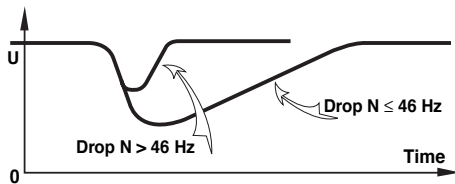

## 2.4 - Typical effects of the LAM with a diesel engine with or without a LAM (U/F only)

### 2.4.1 - Voltage

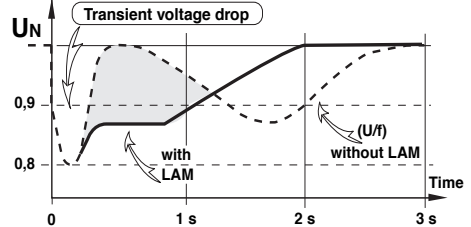

### 2.4.2 - Frequency

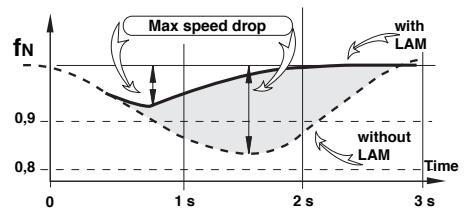

### 2.4.3 - Power

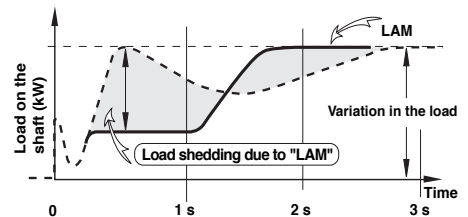

# R 438

## A.V.R.

### 2.5 - R438 A.V.R. options

- **Current transformer** for parallel operation of ...../1A. 5 VA CL 1.

- **Remote voltage adjustment potentiometer:** 470  $\Omega$ , 0.5 W min: adjustment range  $\pm 5\%$  (range limited by internal voltage potentiometer **P2**). Remove ST4 to connect the potentiometer. (A 1 k $\Omega$  potentiometer can also be used to extend the adjustment range).



**For wiring up the external potentiometer; the “earth” wires must be isolated as well as the potentiometer terminals (wires at the same voltage as the power).**

- **R 731 external module:** sensing of 3-phase voltage 200 to 500 V, compatible with parallel operation. Disconnect ST1 to connect the module; set the voltage via the module potentiometer.

- **R 734 module:** detection of 3-phase current and voltage for parallel operation on unbalanced installations (imbalance > 15%).

- **R 726 module:** 3 functions (mounted externally). P.F. regulation (2F) and voltage sensing circuit before paralleling (3 F).

- **Voltage control:** with an **isolated** D.C. current source applied to the terminals used for the external potentiometer:

- Internal impedance 1.5 k $\Omega$ .
- A variation of  $\pm 0.5$  V corresponds to a voltage adjustment of  $\pm 10\%$ .



# R 438

## A.V.R.

### 3 - INSTALLATION - COMMISSIONING

#### 3.1 - Electrical checks on the AVR

- Check that all connections have been made properly as shown in the attached wiring diagram.

- Check that the ST3 frequency selection jumper is on the correct frequency setting.

- Check whether the ST4 jumper or the remote adjustment potentiometer have been connected.

- Optional operating modes.

- ST1 jumper : open to connect the R 731 or R 734 3-phase sensing module.

- ST2 jumper : open if rapid response time used

- ST5 jumper : open to suppress the LAM function.

#### 3.2 - Settings



The machine is tested and set at the factory. When first used with no load, make sure that the drive speed is correct and stable (see the nameplate). After operational testing, replace all access panels or covers.

The only possible adjustments to the machine should be made on the AVR.

##### 3.2.1 - R438 settings (AREP or PMG system)

### WARNING

Before any intervention on the A.V.R., make sure that the ST9 jumper is closed with AREP excitation and disconnected with PMG or SHUNT or separate excitation.

a) Initial potentiometer settings (see table below)

- Remote voltage adjustment potentiometer : centre (ST4 jumper removed).

Action	Factory setting	Pot.
<b>Voltage</b> minimum fully anti-clockwise	400V - 50 Hz (Input 0 - 380 V)	
<b>Stability</b>	Not set (centre position)	
<b>Voltage quadrature droop</b> (// operation with C.T.) - 0 quadrature loop fully anti-clockwise.	Not set (fully anti-clockwise)	
<b>Excitation ceiling</b> Limit of excitation and short-circuit current, minimum fully anti-clockwise.	10 A maximum	

#### Stability adjustments in standalone operation

b) Install a D.C. analogue voltmeter (needle dial) cal. 50V on terminals E+, E- and an A.C. voltmeter cal 300 - 500 or 1000V on the alternator output terminals.

c) Make sure that the **ST3** jumper is positioned on the desired frequency (50 or 60 Hz).

d) Voltage potentiometer **P2** at minimum, fully anti-clockwise.

e) Stability potentiometer **P3** to around 1/3 of the anti-clockwise limit.

f) Start the engine and set its speed to a frequency of 48 Hz for 50 Hz, or 58 for 60 Hz.

g) Set the output voltage to the desired value using **P2**.

- Rated voltage UN for solo operation (eg. 400 V)

- Or UN + 2 to 4% for parallel operation with C.T. (eg. 410 V)

If the voltage oscillates, use P3 to make adjustments (try both directions) observing the voltage between E+ and E- (approx. 10V D.C.).

# R 438

## A.V.R.

The best response times are obtained at the limit of the instability. If no stable position can be obtained, try disconnecting or replacing the ST2 jumper (normal/fast).

h) Check LAM operation : **ST5** closed.

i) Vary the frequency (speed) around 48 or 58 Hz according to the operating frequency, and check the change in voltage from that observed previously (~ 15%).

j) Readjust the speed of the unit to its rated no-load value.  
Adjustments in parallel operation

**Before any intervention on the alternator, make sure that the speed droop is identical for all engines.**

k) Preset for parallel operation (with C.T. connected to S1, S2)

- Potentiometer P1 (quadrature droop) in centre position.

Apply the rated load (P.F. = 0.8 inductive).

The voltage should drop by 2 to 3%. If it increases, check that V and W and also S1 and S2 have not been reversed.

l) The no-load voltages should be identical for all the alternators intended to run in parallel.

- Couple the machines in parallel.

- By adjusting the **speed**, try to obtain **0 KW** power exchange.

- By altering the voltage setting P2 on one of the machines, try to cancel (or minimise) **the current** circulating between the machines.

- From now on, do not touch the voltage settings.

m) Apply the available load (the setting is only correct if a **reactive** load is available)

- By altering the **speed**, match the **kW** (or divide the rated power of the units proportionally)

- By altering the quadrature droop potentiometer **P1**, match or divide the **currents**.

### 3.2.2 - Max. excitation setting (excitation ceiling)

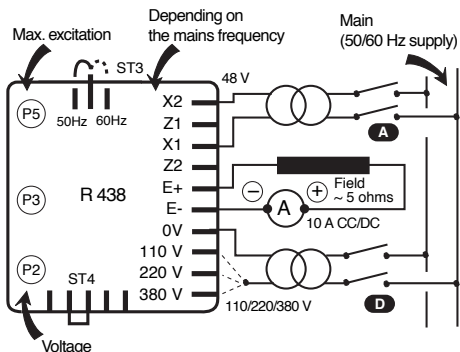

Static adjustment of the current limit, potentiometer P5 (factory setting: 7.5 A, fuse rating: 8 A - 10 seconds).

The maximum factory setting corresponds to that of the excitation current required to obtain a 3-phase short-circuit current of approximately 3 IN at 50 Hz for industrial power, unless otherwise specified\*.)

A static method can be used to reduce this value or adapt the Isc to the actual operating power (derated machine), which is safer for the alternator and the installation. Disconnect power supply wires X1, X2 and Z1, Z2 and the voltage reference (0-110V-220V-380V) on the alternator.

Connect the mains power supply using a transformer (200-240V) as indicated (X1, X2 : 48V). Install a 10A D.C. ammeter in series with the exciter field. Turn P5 fully anti-clockwise and activate the power supply. If there is no output current from the AVR, turn potentiometer P2 (voltage) clockwise until the ammeter indicates a stable current. Switch the power supply off, then on again, turn P5 clockwise until the required max. current is obtained (no more than 8 A).

# R 438

## A.V.R.

### Checking the internal protection :

Open switch (D) : the excitation current should increase to its preset ceiling, remain at that level for  $\geq 10$  seconds and then drop to  $< 1A$ .

To reset, switch off the power supply by opening switch (A).

Note: After setting the excitation ceiling as described, adjust the voltage again (see section 2.1.1)

(\*) In some countries it is a legal requirement to have a short-circuit current of  $3 I_n$ , so as to offer selective protection.

### 3.2.3 - Special type of use

#### WARNING

Excitation circuit E+, E- must not be left open when the machine is running : AVR damage will occur.

#### 3.2.3.1 - R438 field weakening (SHUNT)

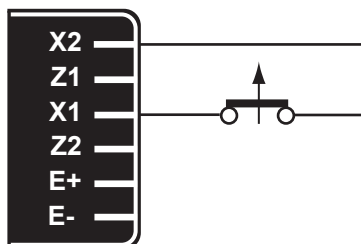

The exciter is switched off by disconnecting the AVR power supply (1 wire - X1 or X2). Contact rating 16 A - 250V A.C.

#### 3.2.3.2 - R438 field weakening (AREP/ PMG)

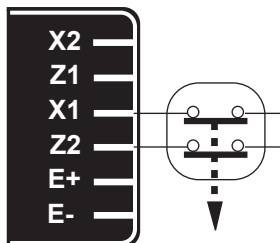

The exciter is switched off by disconnecting the AVR power supply (1 wire on each auxiliary winding) - contact rating 16 A - 250V A.C.

Connection is identical for resetting the AVR internal protection.



**In case of using the de-excitation, provide a forced excitation.**

#### 3.2.3.3 - R438 field forcing

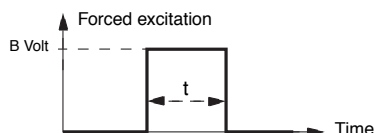
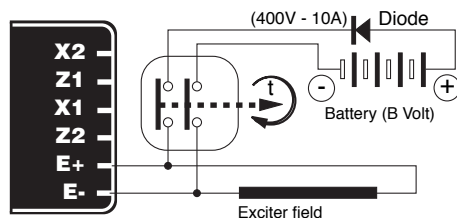

Applications	B volts	Time t
Guaranteed voltage build-up	12 (1A)	1 - 2 s
Parallel operation, de-energized	12 (1A)	1 - 2 s
Parallel operation, at standstill	12 (1A)	5 - 10 s
Frequency starting	12 (1A)	5 - 10 s
Sustained voltage on overload	12 (1A)	5 - 10 s

# R 438

## A.V.R.

### 3.3 - Electrical faults

Fault	Action	Effect	Check/Cause
No voltage at no load on start-up	Connect a new battery of 4 to 12 volts to terminals E- and E+, respecting the polarity, for 2 to 3 seconds	The alternator builds up and its voltage is still correct when the battery is removed.	- Lack of residual magnetism
		The alternator builds up but its voltage does not reach the rated value when the battery is removed.	- Check the connection of the voltage reference to the AVR - Faulty diodes - Armature short-circuit
		The alternator builds up but its voltage disappears when the battery is removed	- Faulty AVR - Field windings disconnected - Main field winding open circuit - check the resistance
Voltage too low	Check the drive speed	Correct speed	Check the AVR connections (AVR may be faulty) - Field windings short-circuited - Rotating diodes burnt out - Main field winding short-circuited - Check the resistance
		Speed too low	Increase the drive speed (Do not touch the AVR voltage pot. (P2) before running at the correct speed.)
Voltage too high	Adjust AVR voltage potentiometer	Adjustment ineffective	Faulty AVR
Voltage oscillations	Adjust AVR stability potentiometer	If no effect : try normal / fast recovery modes (ST2)	- Check the speed : possibility of cyclic irregularity - Loose connections - Faulty AVR - Speed too low when on load (or U/F bend set too high)
Voltage correct at no load and too low when on load (*)	Run at no load and check the voltage between E+ and E- on the AVR	Voltage between E+ and E-SHUNT < 20 V AREP / PMG < 10V	- Check the speed (or U/F bend set too high)
		Voltage between E+ and E-SHUNT > 30V AREP / PMG > 15V	- Faulty rotating diodes - Short-circuit in the main field. Check the resistance - Faulty exciter armature.
<b>(*) Caution :</b> For single-phase operation, check that the sensing wires coming from the AVR are correctly connected to the operating terminals			
Voltage disappears during operation (**)	Check the AVR, the surge suppressor, the rotating diodes, and replace any defective components	The voltage does not return to the rated value.	- Exciter winding open circuit - Faulty exciter armature - Faulty AVR - Main field open circuit or short-circuited
<b>(**) Caution :</b> Internal protection may be activated (overload, open circuit, short-circuit)			



**Warning : after operational testing, replace all access panels or covers.**

# R 438

## A.V.R.

## 4 - SPARE PARTS

### 4.1 - Designation

Description	Type	Code
A.V.R.	R 438	AEM 110 RE 017

### 4.2 - Technical support service

Our technical support service will be happy to provide any information you require.

When ordering spare parts, you should indicate the complete machine type, its serial number and the information indicated on the nameplate.

Part numbers should be identified from the exploded views and their description in the parts list.

Our extensive network of «service stations» can dispatch the necessary parts without delay.

To ensure correct operation and the safety of our machines, we recommend the use of original manufacture spare parts.

In the event of failure to comply with this advice, the manufacturer cannot be held responsible for any damage.

**R 438**  
**A.V.R.**

**R 438**  
**A.V.R.**

**EMERSON. CONSIDER IT SOLVED.™**

[www.emerson.com/epg](http://www.emerson.com/epg)

**Leroy-Somer™**

